

Colour centers in diamond

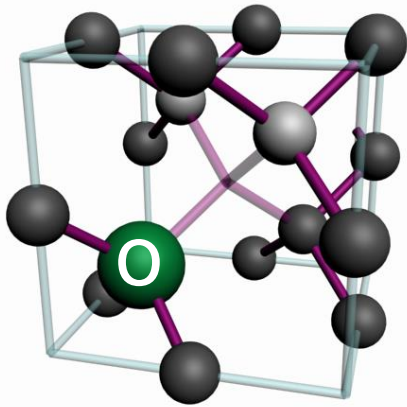

Slides provided by:
Joerg Wrachtrup
Ronald Hanson
Lilly Childress

The dopants



TR12

PRB 72, 035214 2005

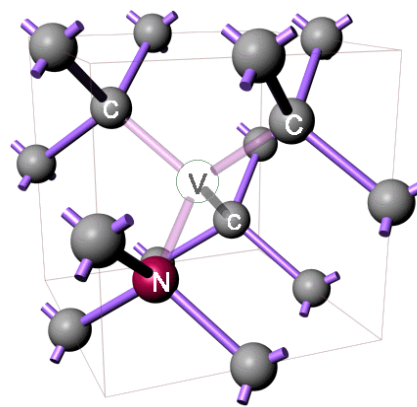
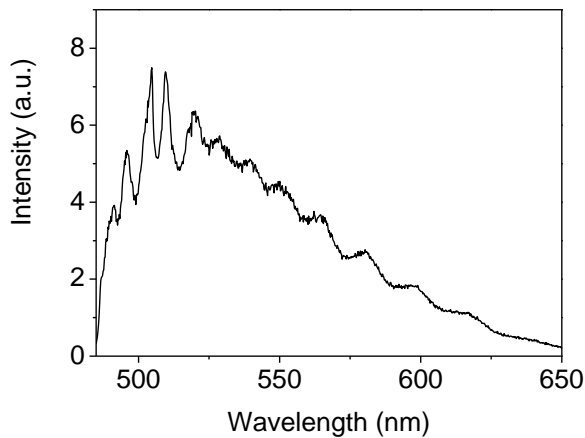

NV

Science 276, 2012-2014 (1997)

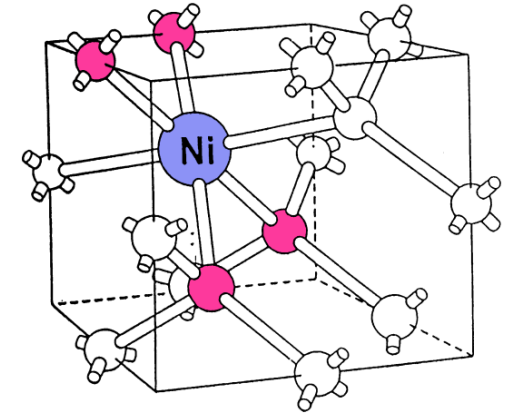
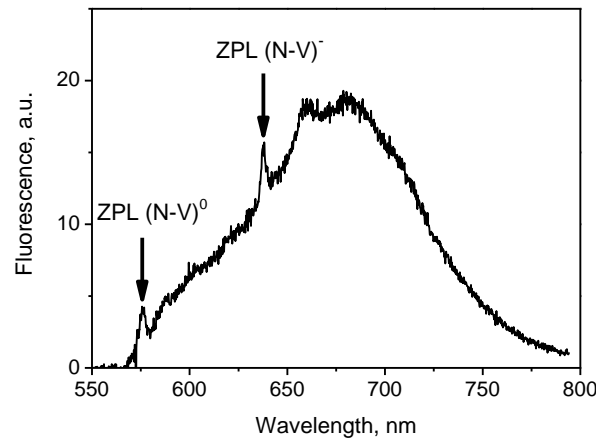

NE8b

Phys. Rev. Lett. **94**, 180602 (2005)

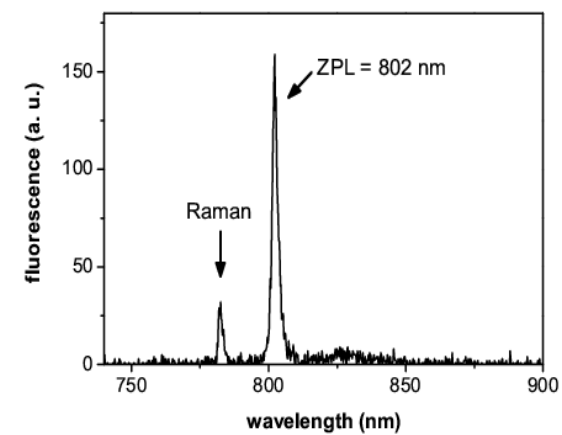

Level scheme of color centers

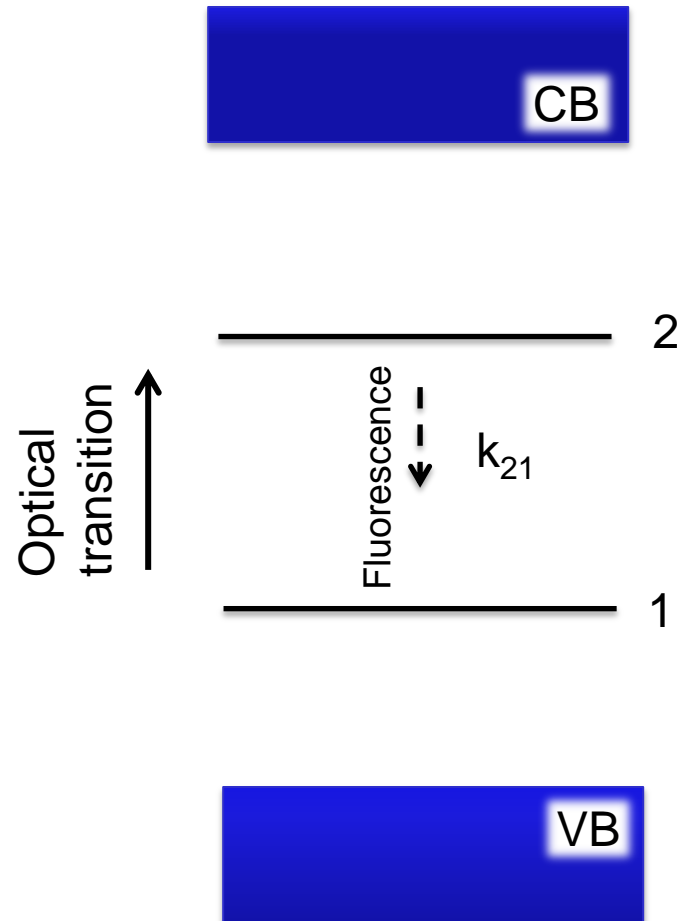

Shielding by the diamond lattice provides perfect photostability

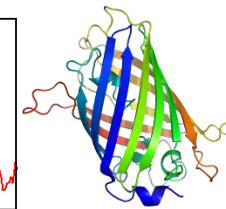
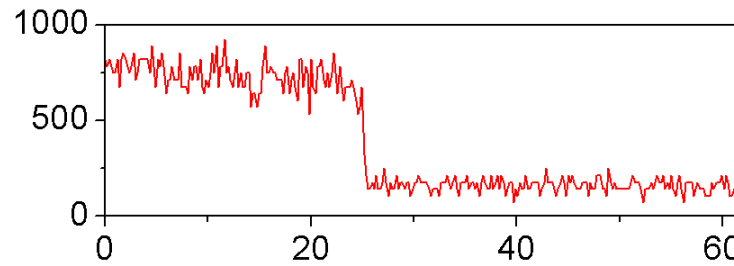
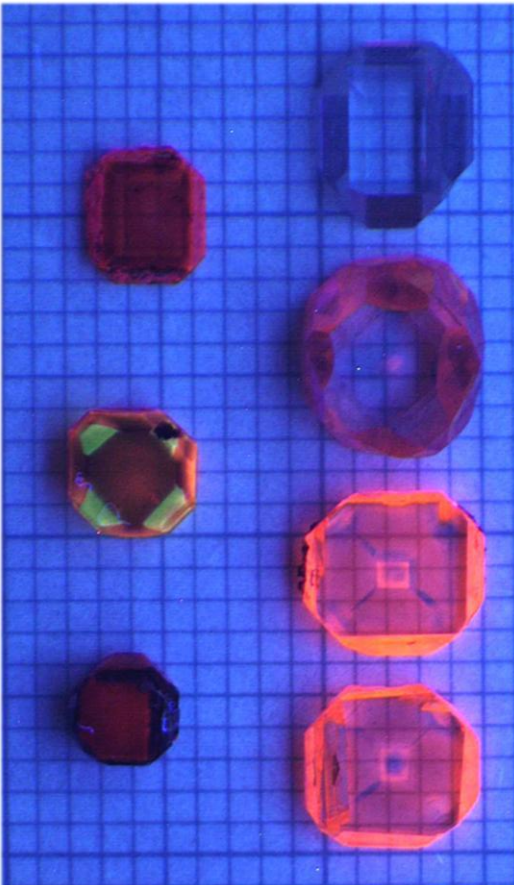

⇒ Oxidation

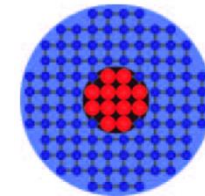
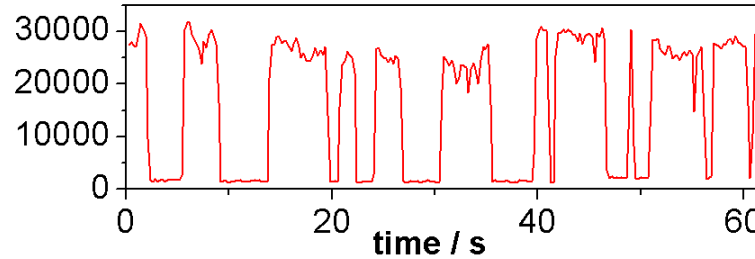

QD

⇒ ionization

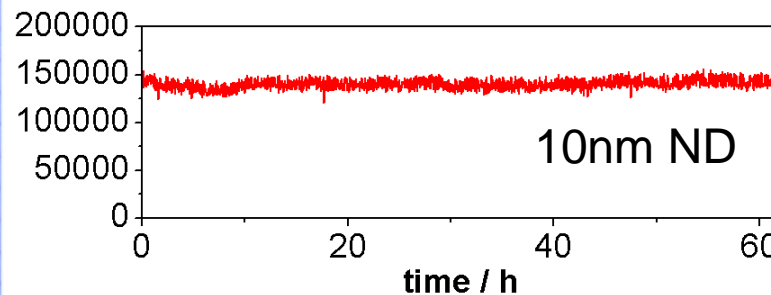

10nm ND

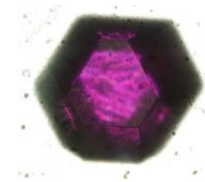

⇒ perfect stability

Level structure of color centers

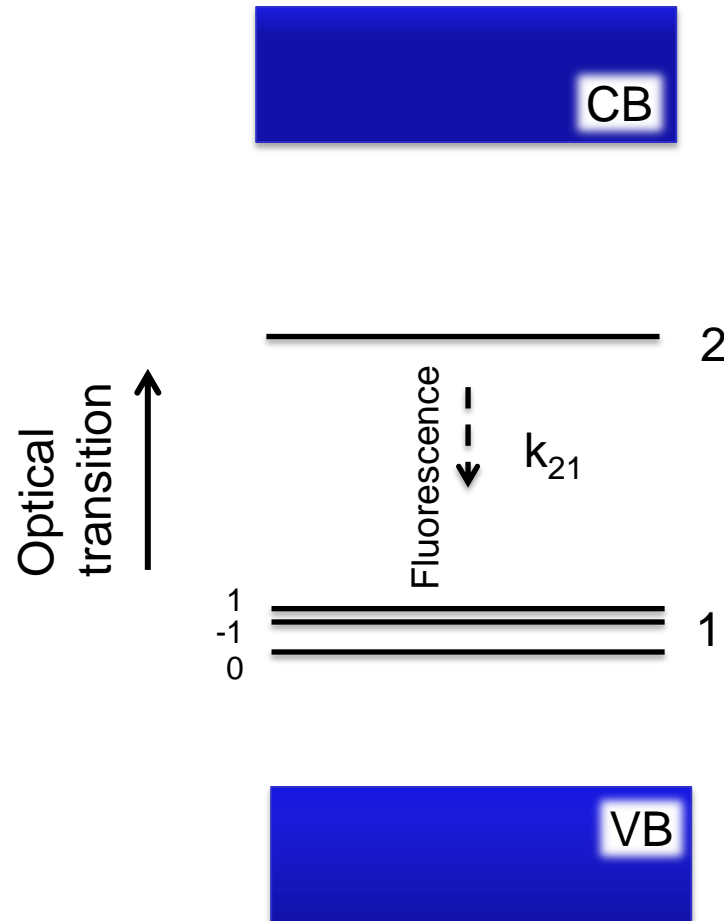

Even electron spin states are resolvable

Defect behaves as a single atom, trapped in the diamond lattice

Level structure similar to trapped ions or atoms

⇒ Diamond provides a solid state ion trap

⇒ Experimental power similar to trapped particles, but much easier to transform into applications

The NV center

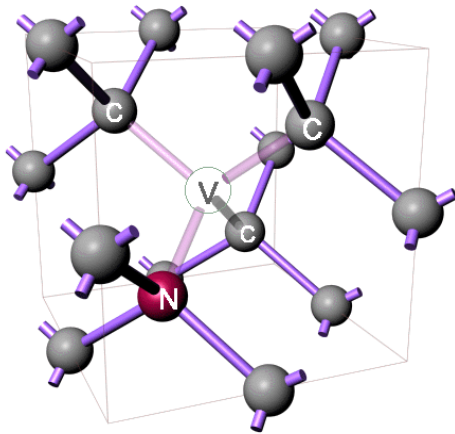

- Joint defect consisting of
 - Vacancy
 - Neighbouring substitutional N
- Negatively charged (NV^-)
- Six electron (= two hole) system

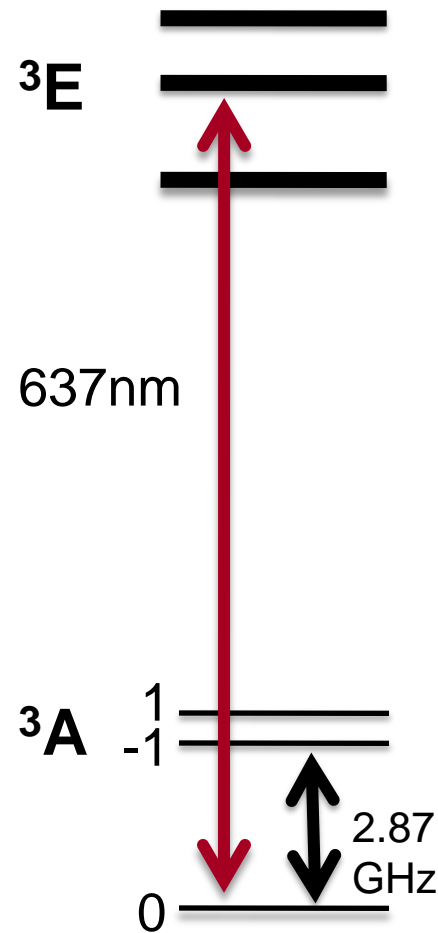

The NV center

Amazing features:

- Optical detection of the spin state
- Optical spin polarisation of the ground state (« Laser cooling »)
- Narrow lines, $T_2 = 1\text{ms}$, Linewidth of ground state levels: 1 kHz.

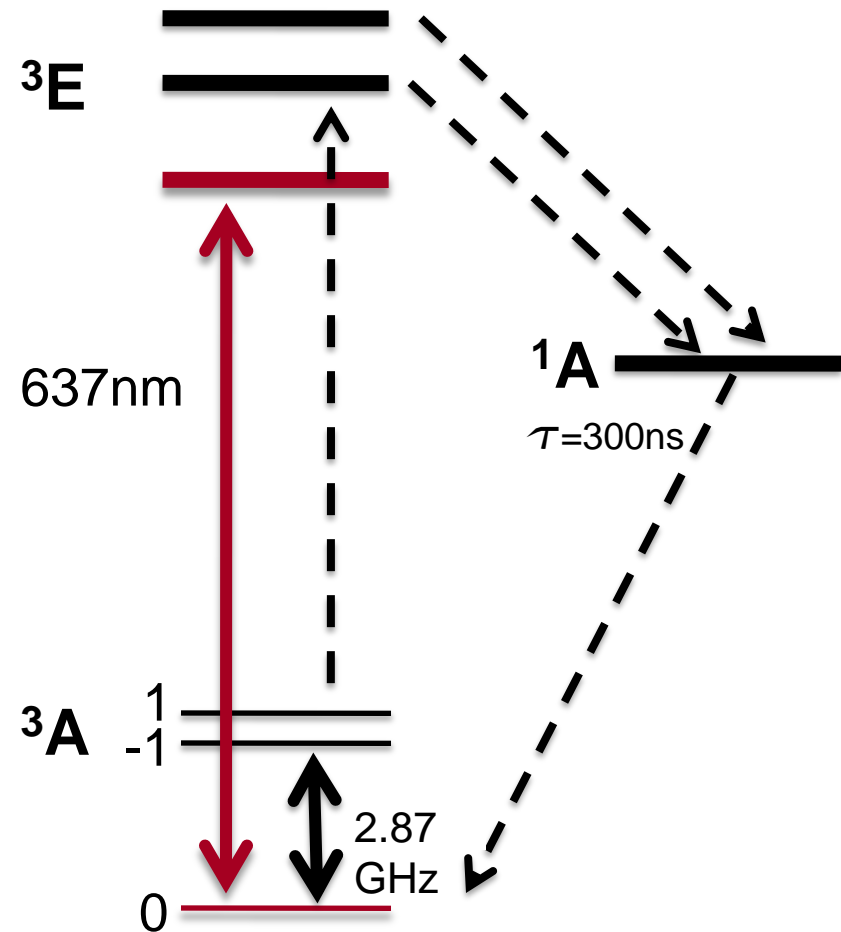

The NV center

Amazing features:

- Optical detection of the spin state
- Optical spin polarisation of the ground state (« Laser cooling »)
- Narrow lines, $T_2 = 1\text{ms}$, Linewidth of ground state levels: 1 kHz.

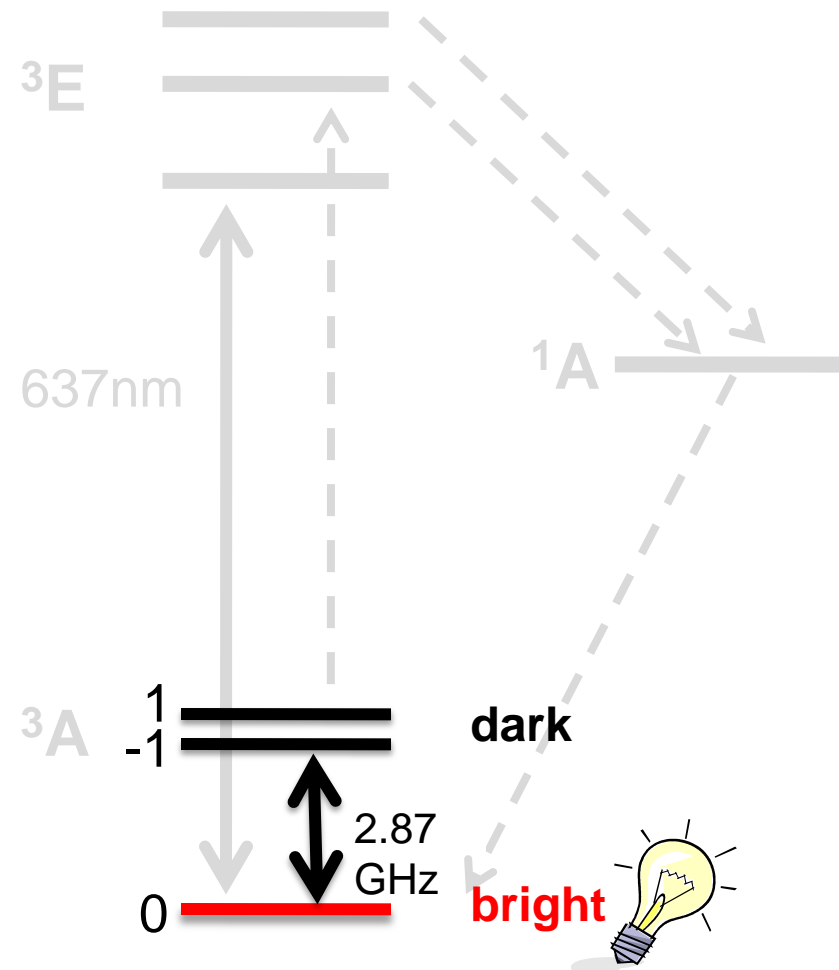

Experimental setup for optical spin readout

Confocal microscope with microwave access

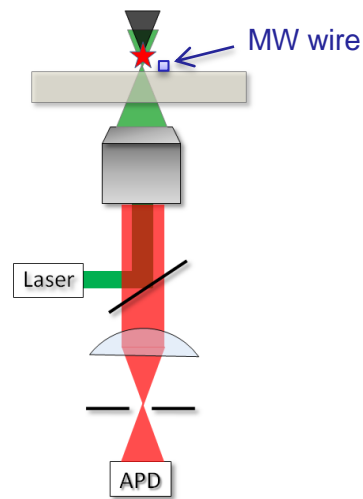
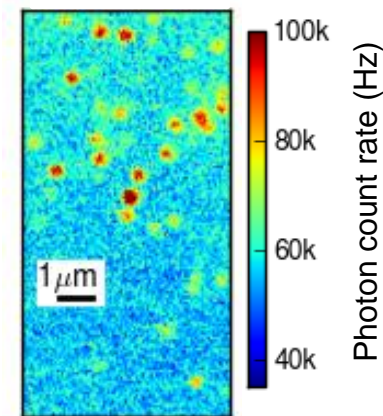
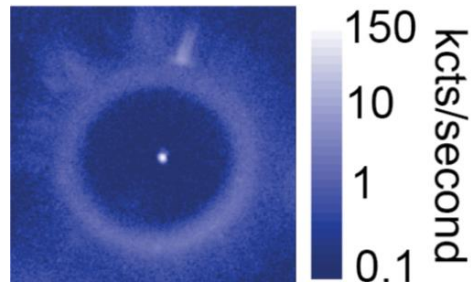

Image of implanted diamond



Wiring up NV centers



dc Stark tuning:

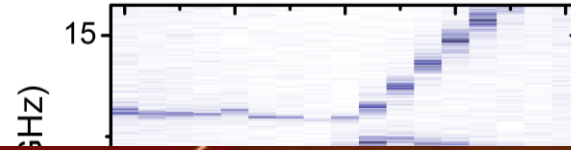

deterministically placed SIL:

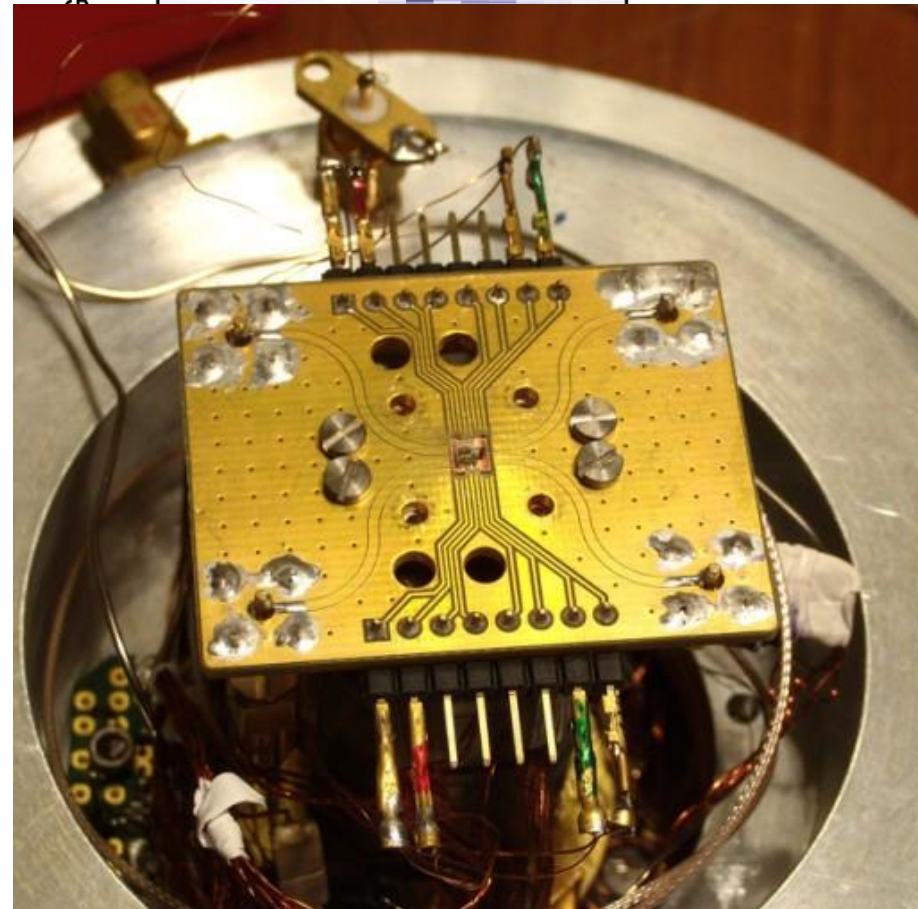
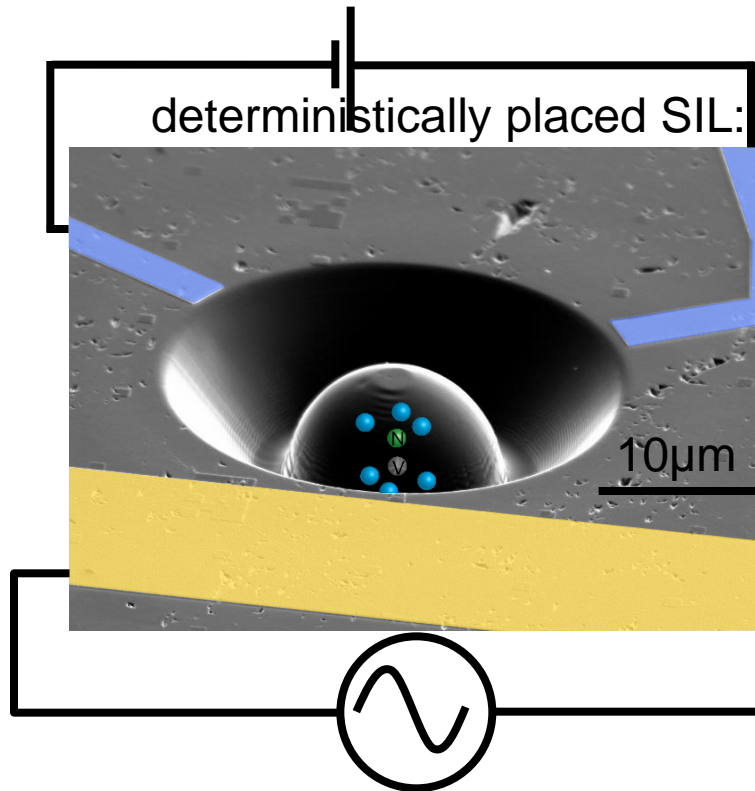

CVD diamonds grown by Element6

Spin-resolved optical excitation ($T < 10\text{K}$)

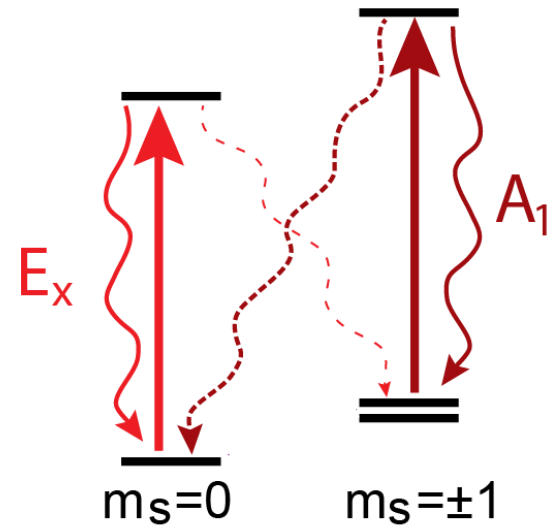
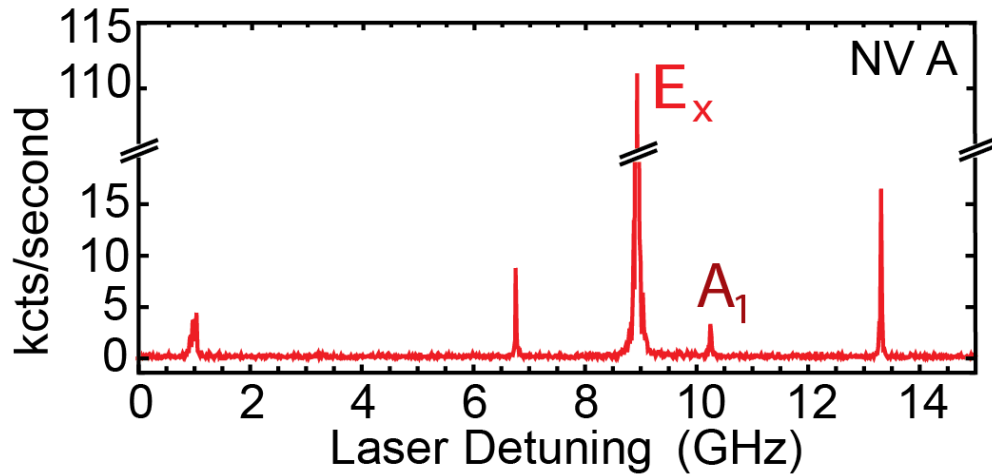

Initialization and readout by resonant excitation

Nature 477, 574 (2011)

Initialization

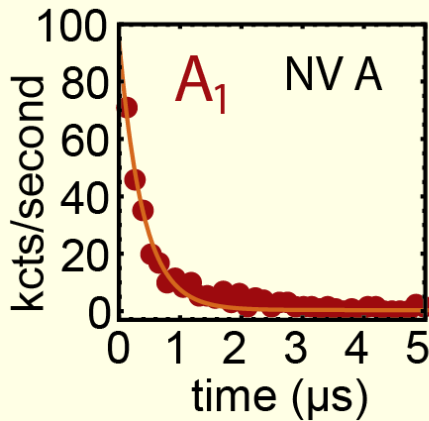
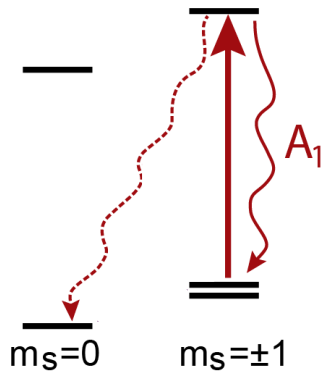

fidelity > 99.7%

Single-Shot Readout

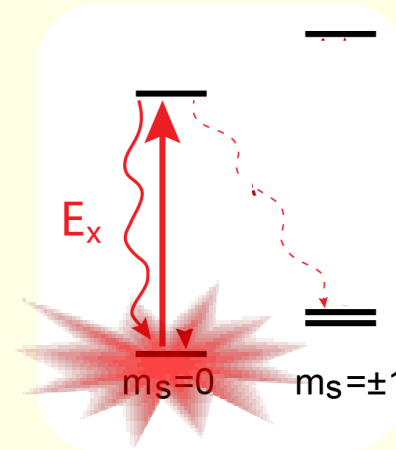

**our best
fidelity \approx 98%**

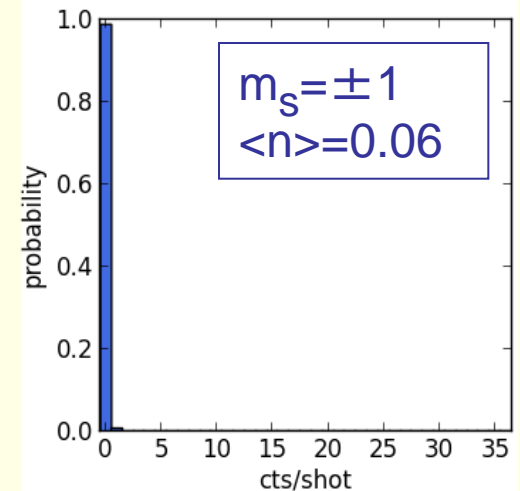
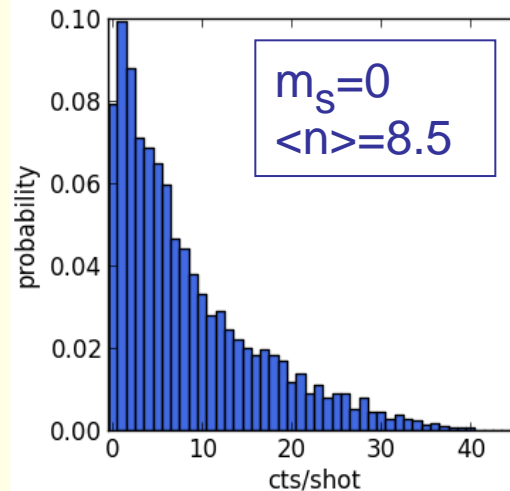

Manipulating a single spin

Experimental sequence

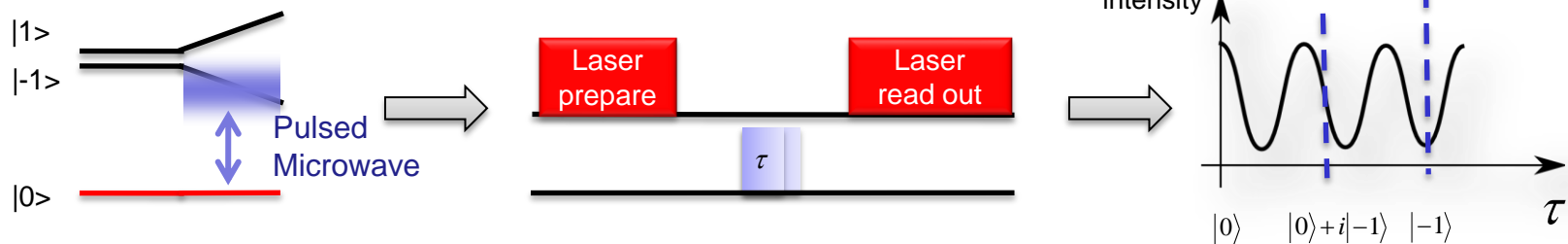

- Pulsed sequence consisting of laser cooling, spin manipulation and detection
 - Signal is $\langle 1 \text{ photon/repetition} \Rightarrow$ many repetitions
- \Rightarrow Similar to ion trap, but experimentally easier

The NV center

Amazing features:

- Optical detection of the spin state
- Optical spin polarisation of the ground state (« Laser cooling »)
- Narrow lines, $T_2 = 1\text{ms}$, Linewidth of ground state levels: 1 kHz.

Single Qubit gates: Microwave pulses

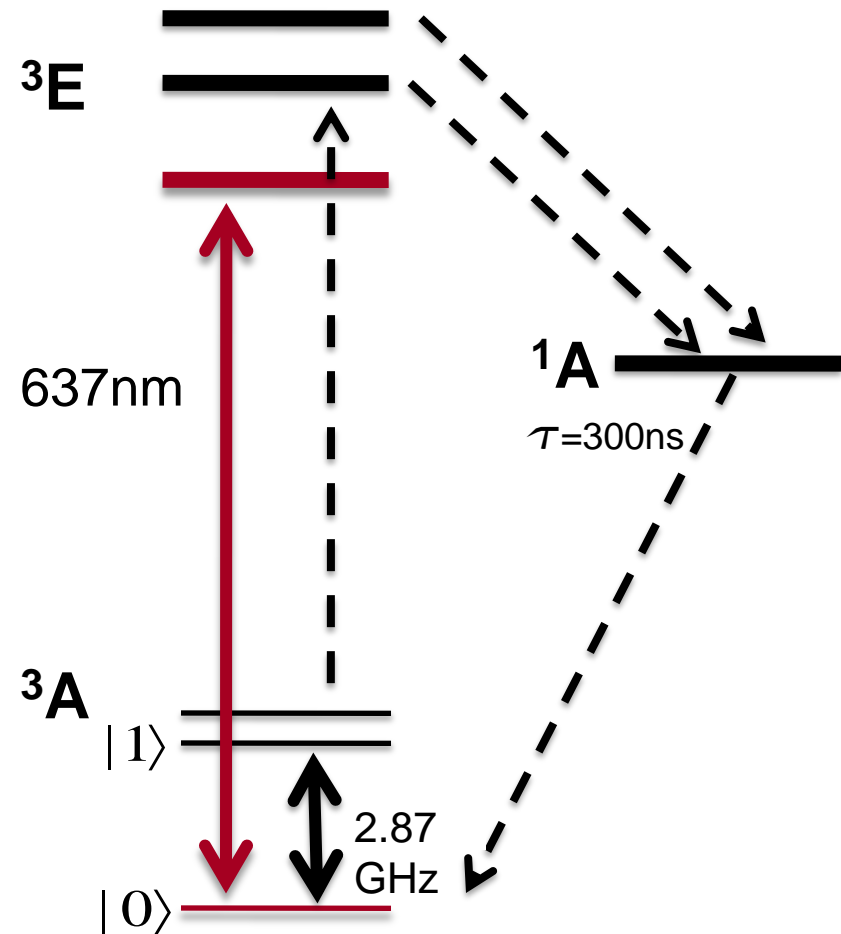
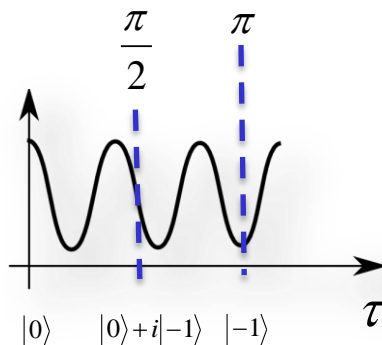

Coupling NV centers

Photons

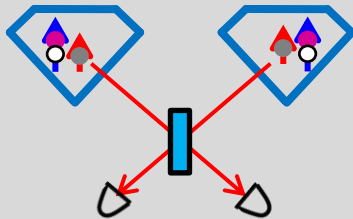

Cirac, Zoller
Lukin `06

- Proper levels and transitions

Manson, Hemmer, Santori

- Transfer limited photons:
Batalov et al. PRL 08

- But: bad coupling efficiency

Magnetic Dipolar coupling

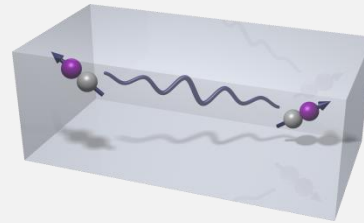

- Magnetic dipoles

$$d_{\text{coherent}} \propto \sqrt[3]{T_2}$$

Use nuclear spin qubits

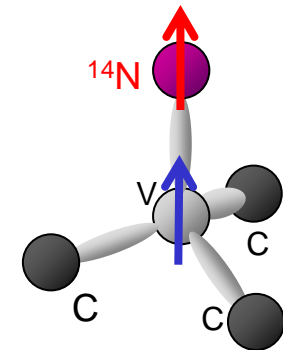

- Couple NV to surrounding nuclei
- Couple nuclei via NV
- Read out single nuclei

Coupling NV centers

Photons

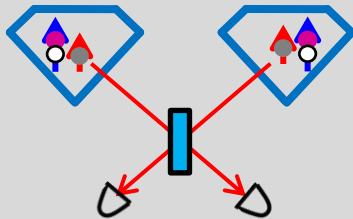

Cirac, Zoller
Lukin `06

- Proper levels and transitions

Manson, Hemmer, Santori

- Transfer limited photons:
Batalov et al. PRL 08

- But: bad coupling efficiency

Magnetic Dipolar coupling

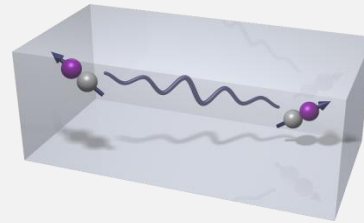

- Magnetic dipoles

$$d_{\text{coherent}} \propto \sqrt[3]{T_2}$$

Use nuclear spin qubits

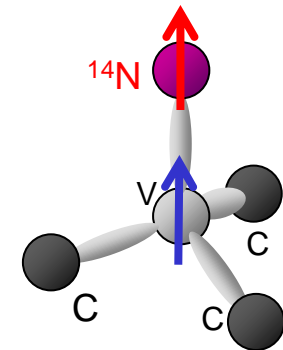

- Couple NV to surrounding nuclei
- Couple nuclei via NV
- Read out single nuclei

Coupling by dipolar interaction

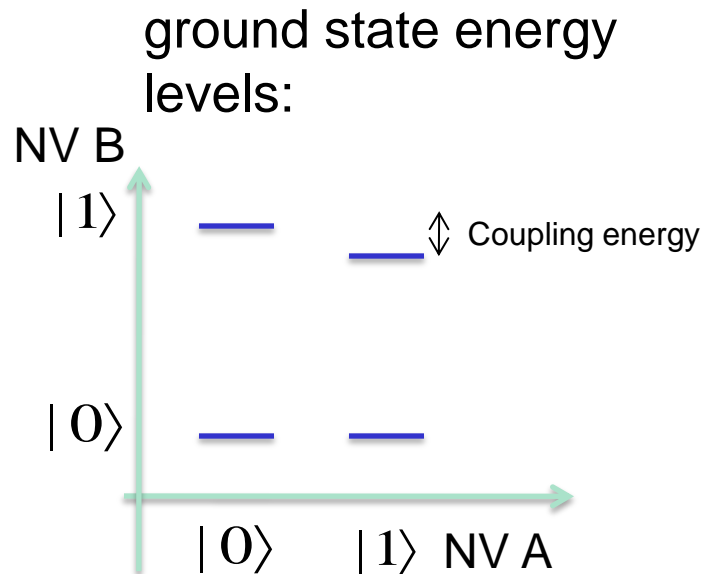

$$H \equiv g\beta\mathbf{BS}_{A,B} + (\mathbf{S}\bar{\mathbf{D}}\mathbf{S})_{A,B}$$

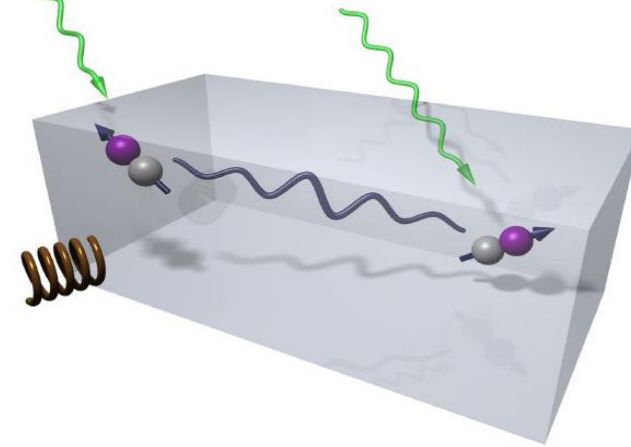

Idea:

\Rightarrow NV B feels the magnetic dipole of NV A

\Rightarrow Depending on the state NV A, NV B has another resonance frequency

Nuclear spin Hamiltonian

Coupled spins $J > 0$: antiferro mag.

$J < 0$: ferro-mag.

$$\mathcal{H}_J = \hbar \sum_{i < j}^n 2\pi J_{ij} I_z^i I_z^j$$

coupling term

Typical values: J up to few 100 Hz

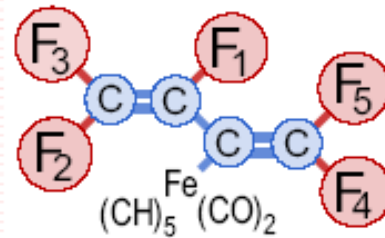

16 configurations

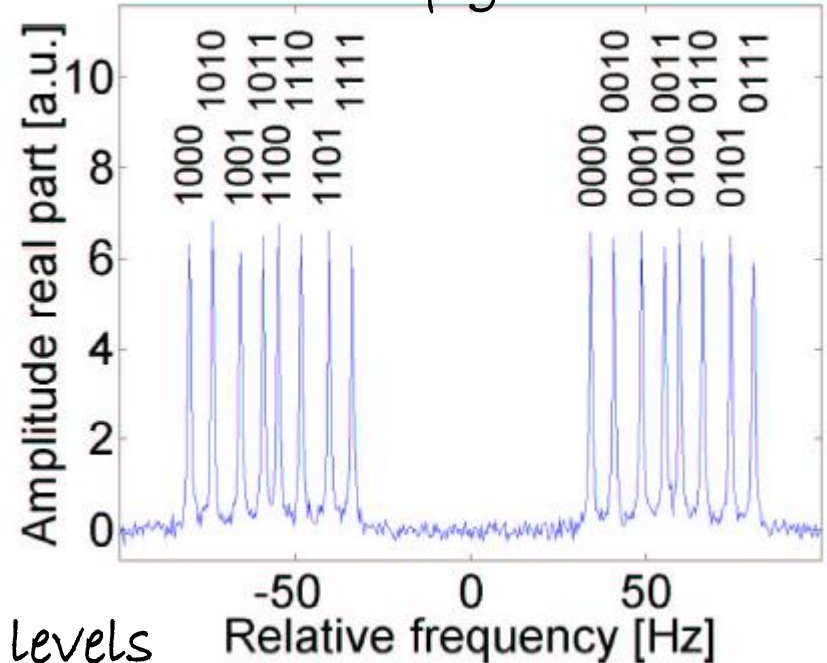
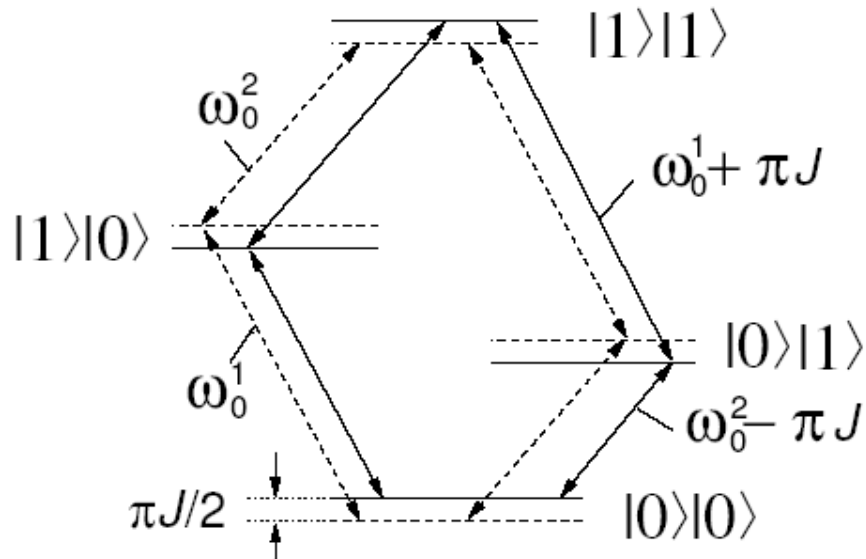

solid (dashed) lines are (un)coupled levels

Magnetic dipole coupled spin arrays

Single spin readout

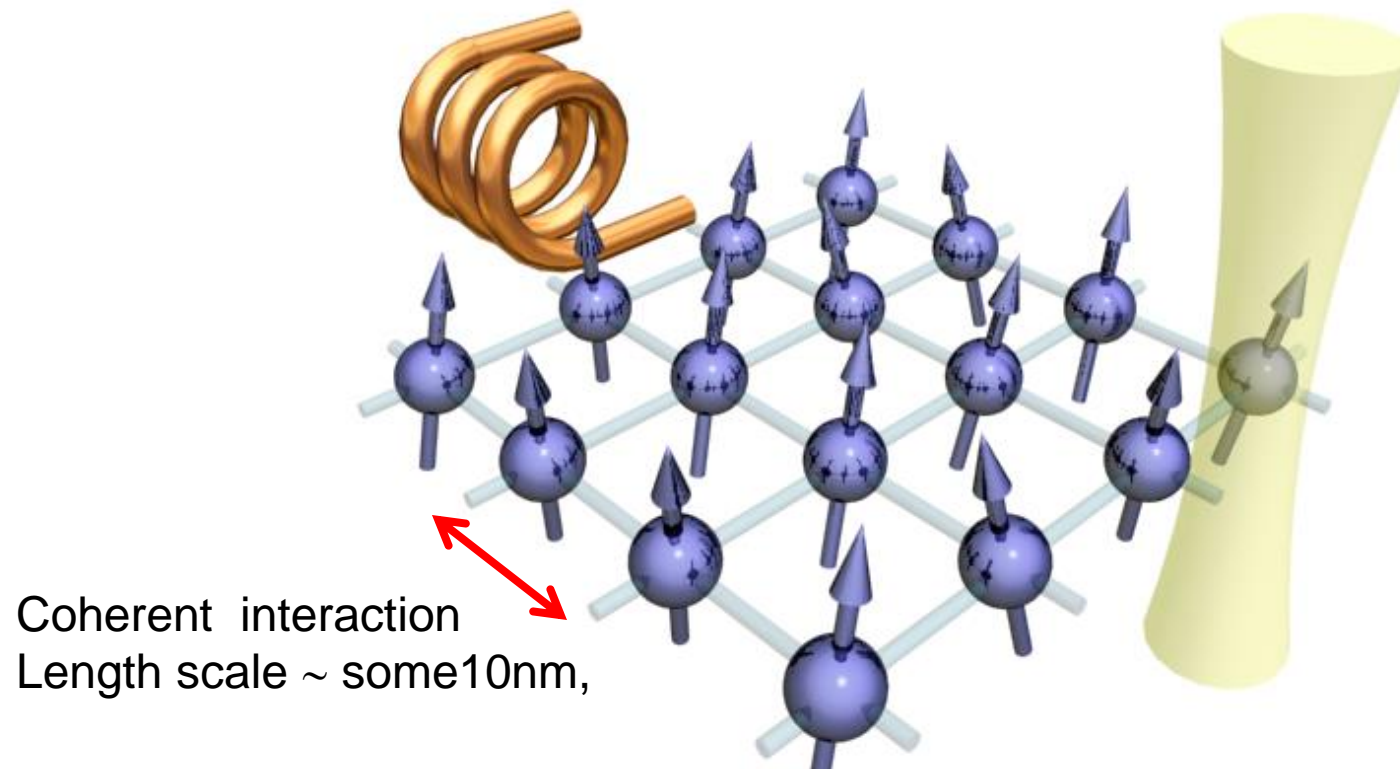

STED on NV: 10nm resolution (Hell et al. Nat. Phot. 2009)

Magnetic dipole coupled spin arrays

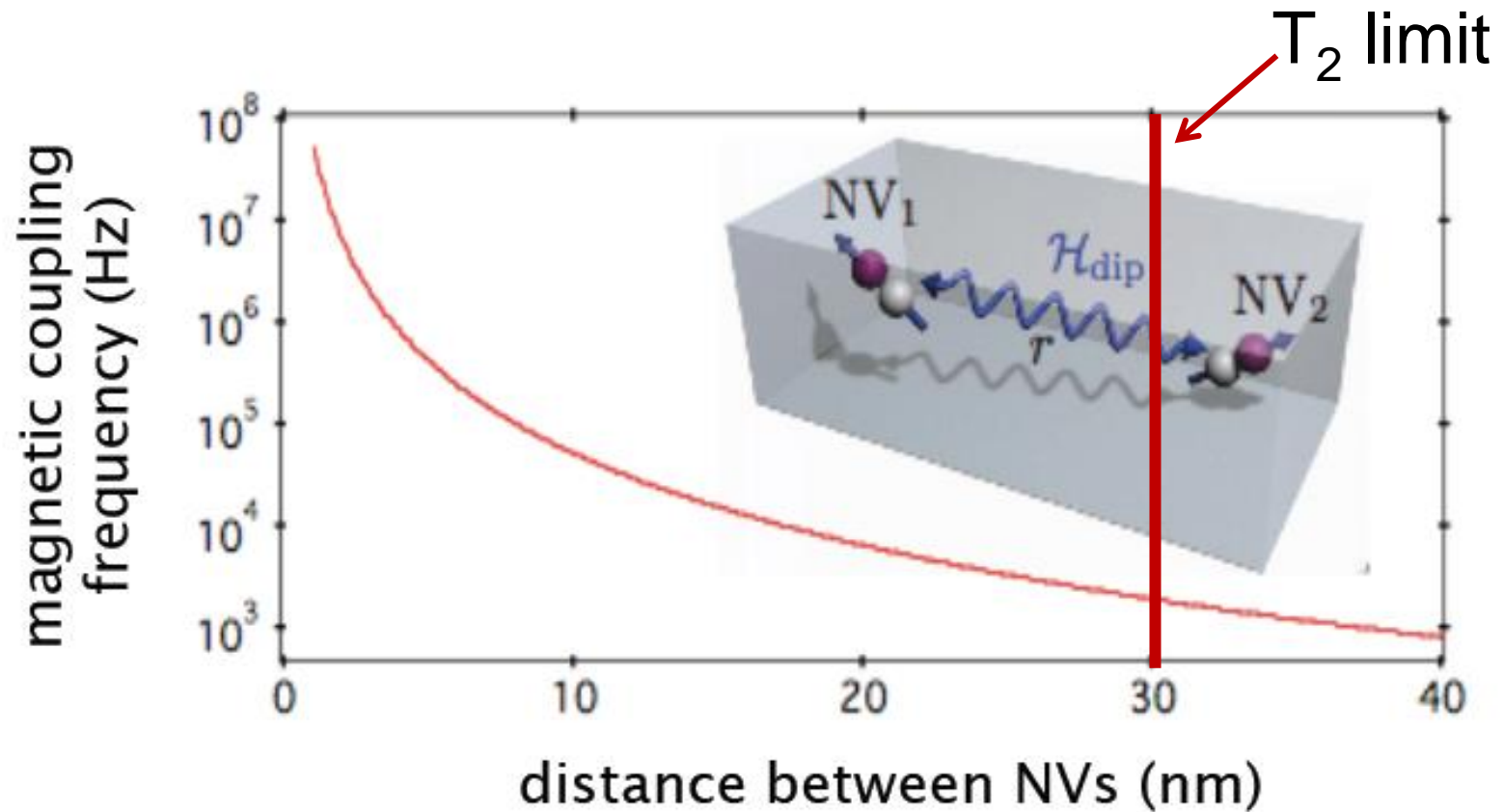

Take pure (CVD) diamond... *



*Element Six Ltd., UK

..and implant nitrogen*! (*J.Meijer; S. Prawer)

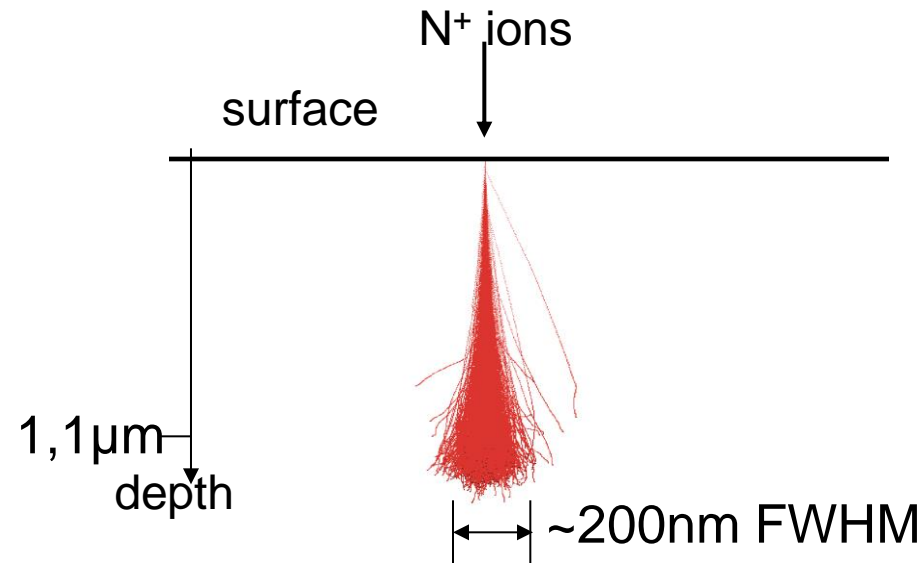
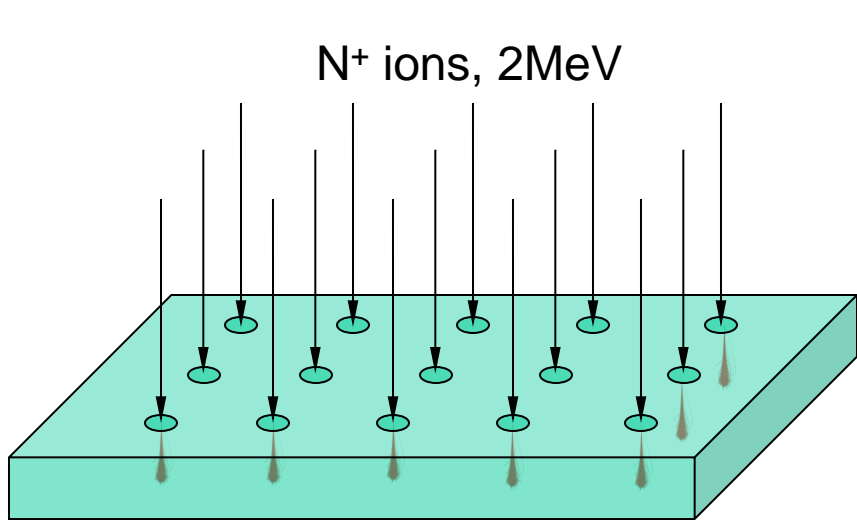

Annealing
at
900° C

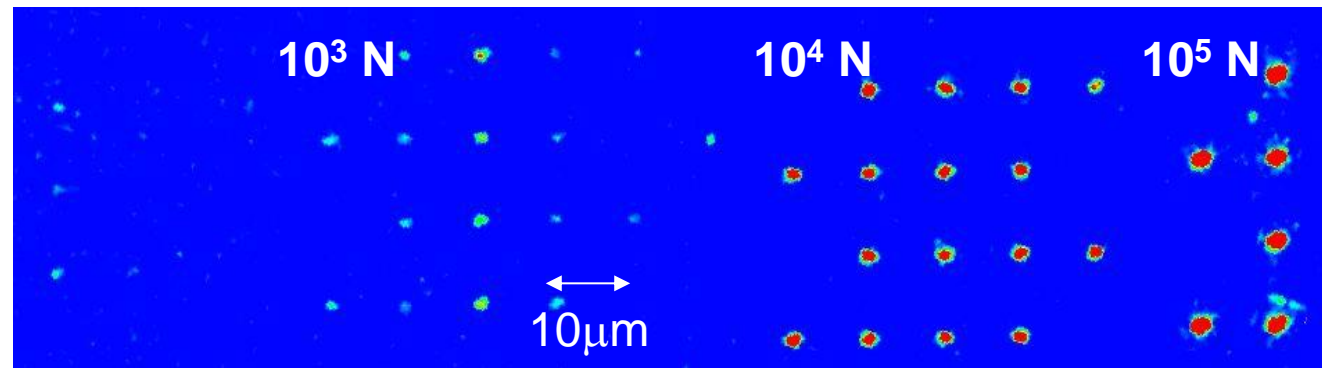

Fundamental problem: Straggle

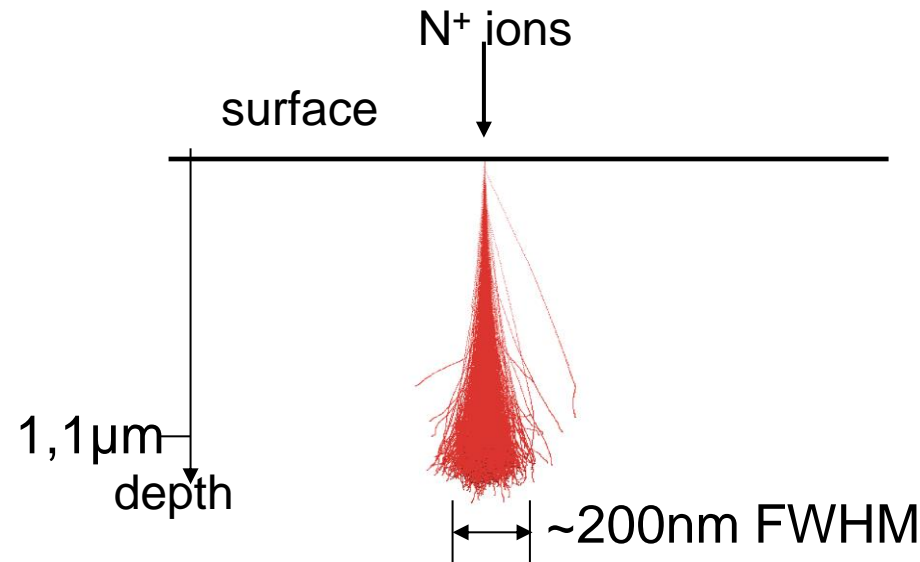

⇒ Position is not controlled

⇒ Straggle on the order of the implantation depth

⇒ Deep implant \leftrightarrow high distance between NVs

Shallow implant \leftrightarrow bad T₂ time due to surface

⇒ Solutions:

Shallow implant + Overgrowth

deep implant + extensive search

Writing Defect Dimers with 10 MeV μ beam implantation

- Success chance 1% to have two coherently interacting dimers

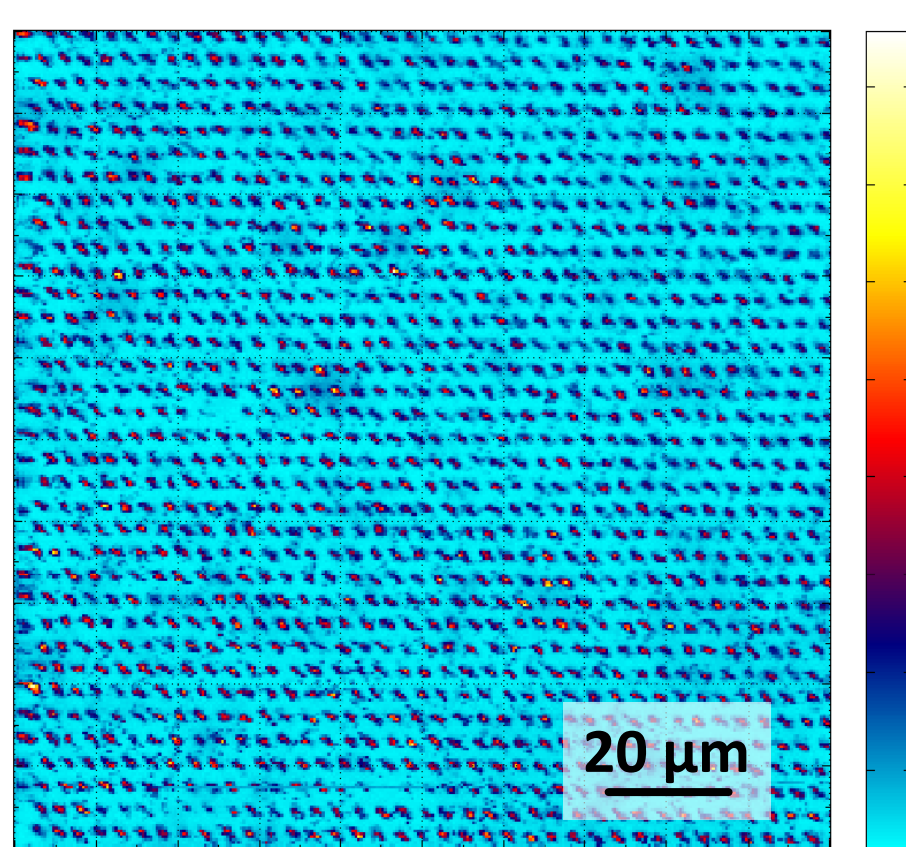

Two defect centers

Electron spin ground state:

$$H = g\beta\mathbf{B}\mathbf{S}_{A,B} + (\mathbf{S}\bar{\mathbf{D}}\mathbf{S})_{A,B} + S_A\bar{\mathbf{T}}S_B$$

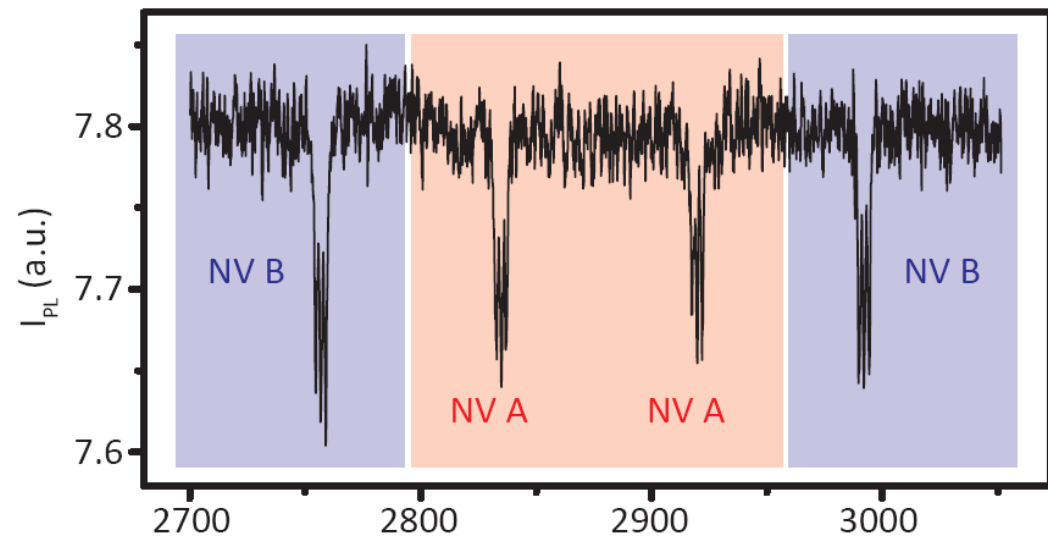
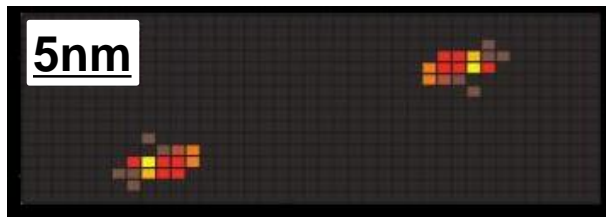
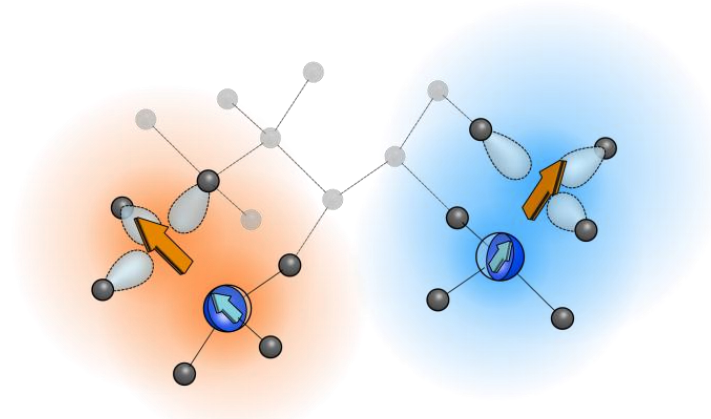
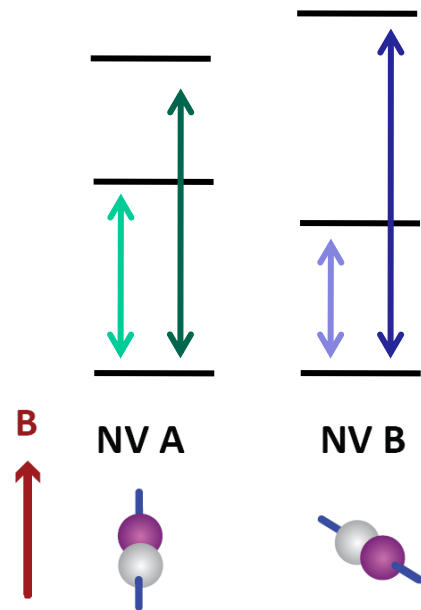

Dipolar coupling: Switching of Spin B

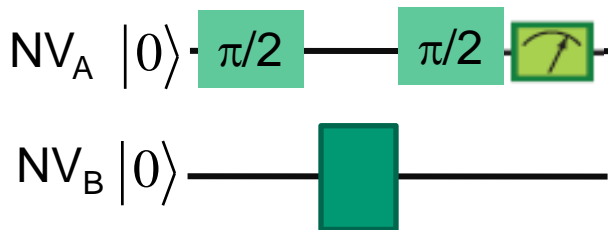
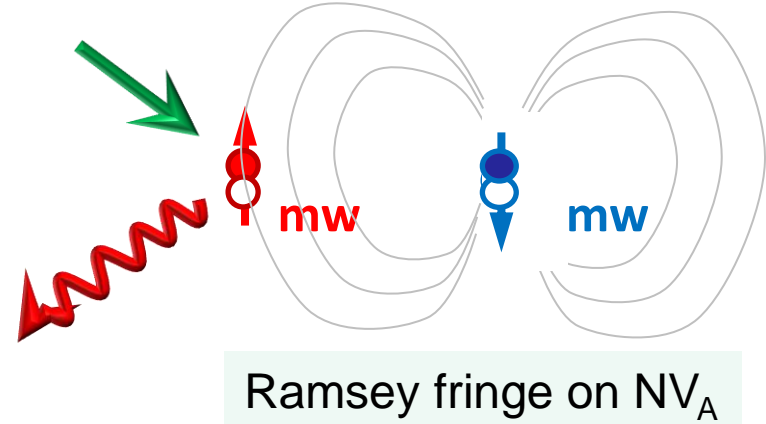
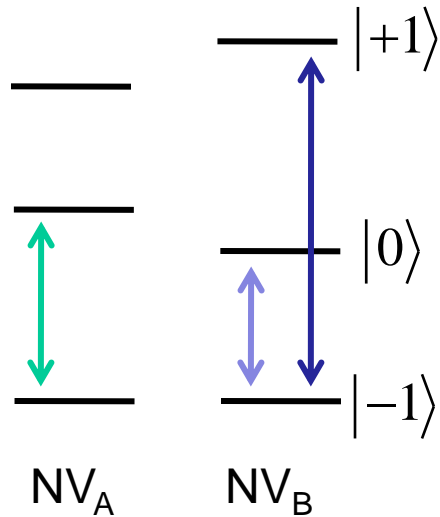

Initial state $F \geq 85\%$

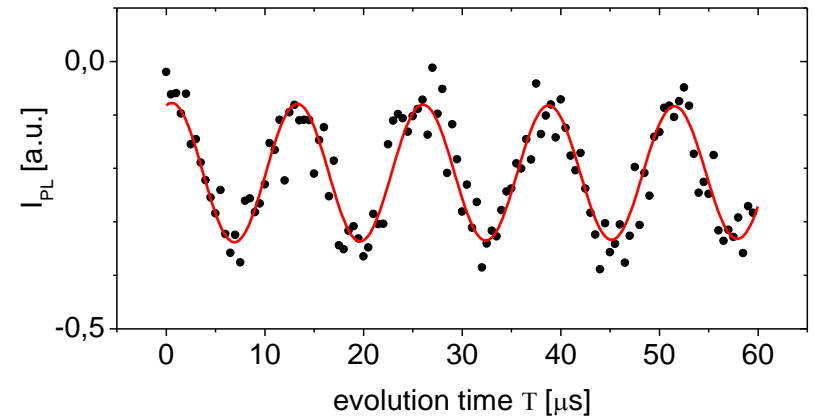

Switchable interaction! Coupling between defect: 0,5,10,20 kHz

Controlled-NOT in NMR

A target bit
B control bit

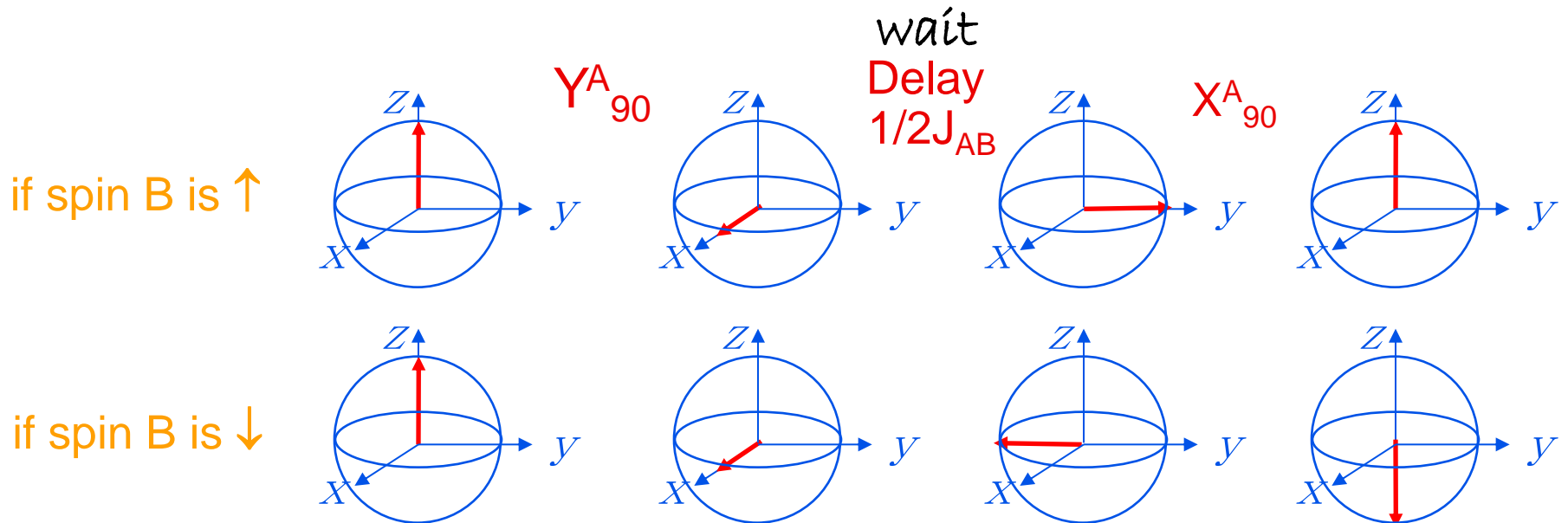
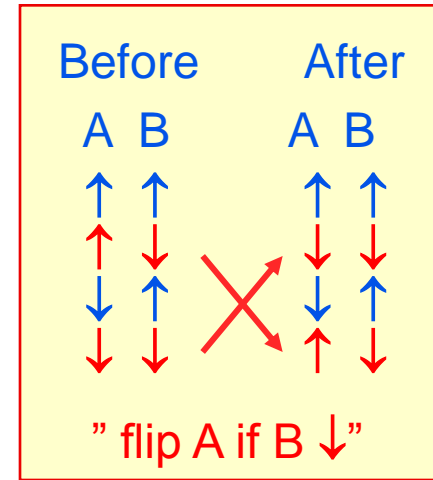
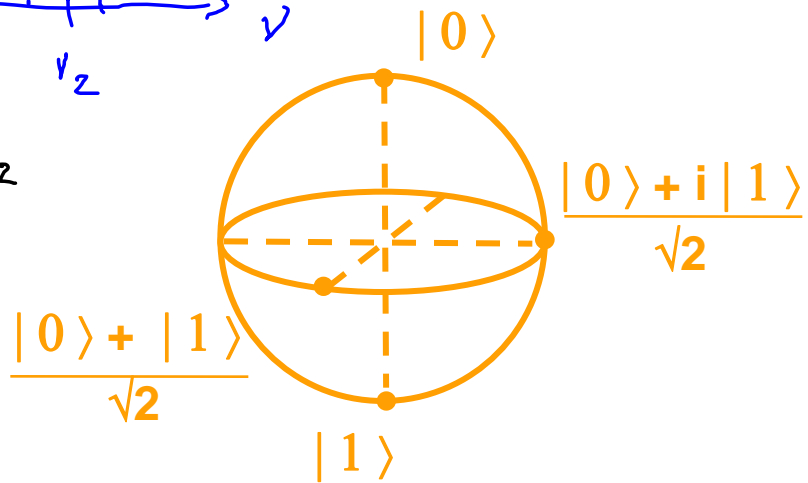
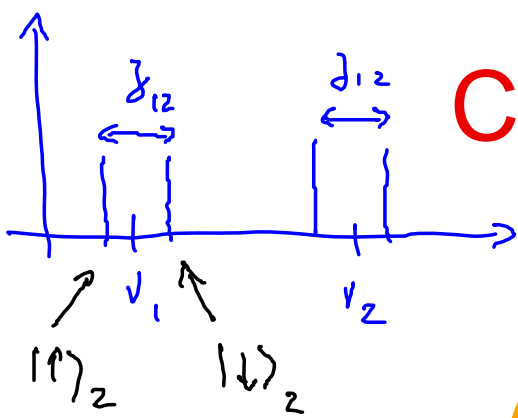

different rotation direction depending on control bit \longrightarrow time

Bell state: Density matrix tomography

$$\Phi_+ = \frac{1}{\sqrt{2}}(|++\rangle + |--\rangle)$$

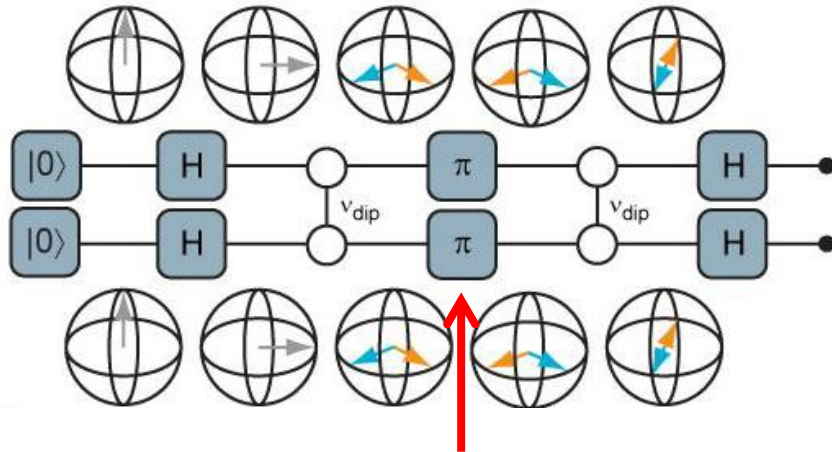

decoupling

Fidelity Φ_+ : 0.67
(theoretically: 0.9)

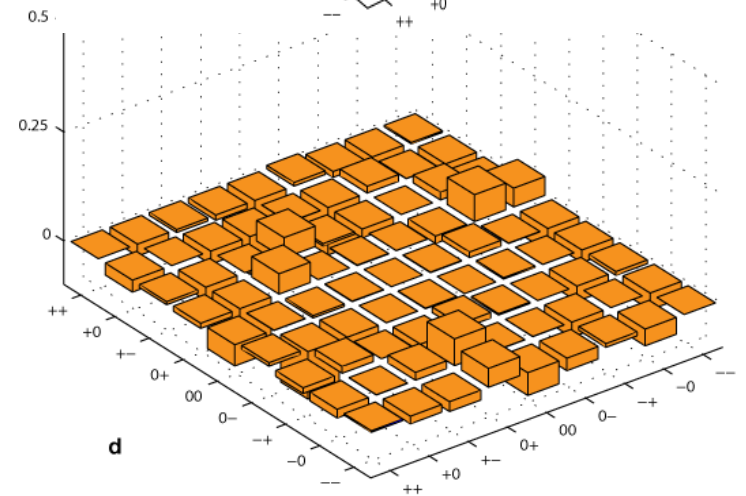
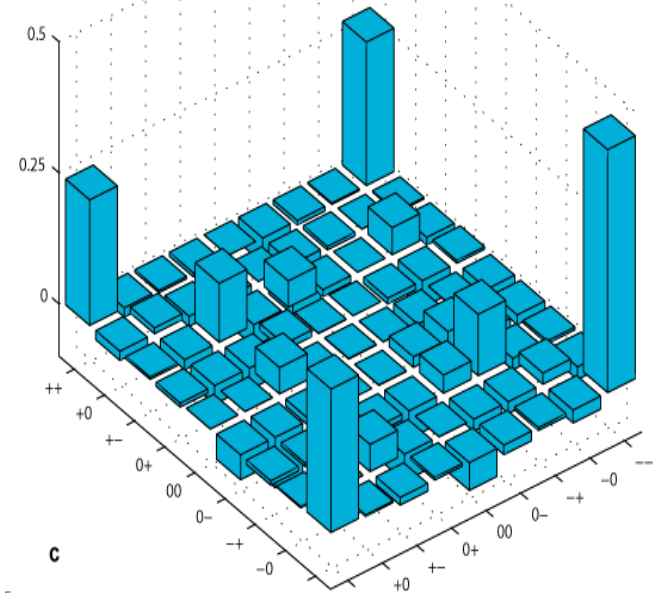

Coupling NV centers

Photons

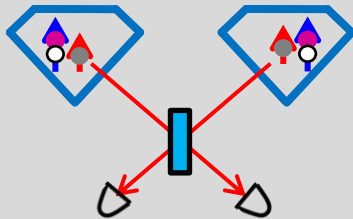

Cirac, Zoller
Lukin `06

- Proper levels and transitions

Manson, Hemmer, Santori

- Transfer limited photons:
Batalov et al. PRL 08
- But: bad coupling efficiency

Magnetic Dipolar coupling

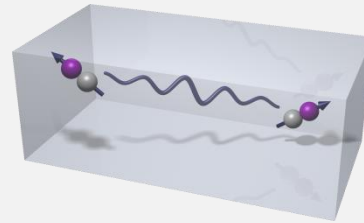

- Magnetic dipoles

$$d_{\text{coherent}} \propto \sqrt[3]{T_2}$$

Use nuclear spin qubits

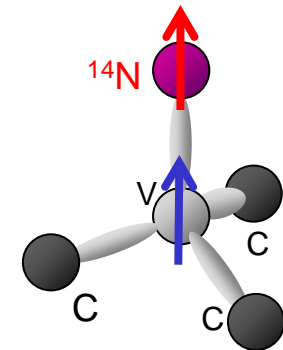

- Couple NV to surrounding nuclei
- Couple nuclei via NV
- Read out single nuclei

Coupling nearby ^{13}C nuclei

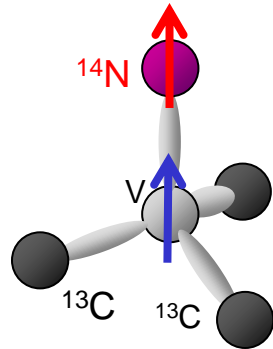

- ^{13}C nuclear spin creates magnetic field at NV
- CNOT gate is implemented by selective microwave transition (flip nucleus if other nucleus is in $|0\rangle$)

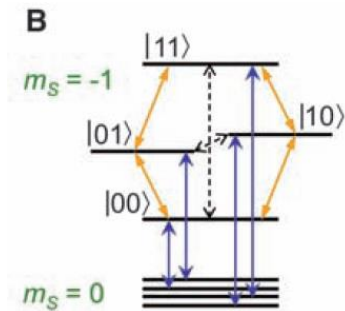

↔ Flip NV
conditioned
on nuclear
state

↔ Flip nuclei
conditioned
on NV and nuclear
state

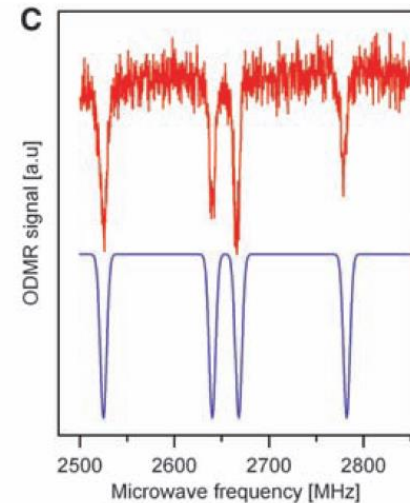

Creation of entangled states

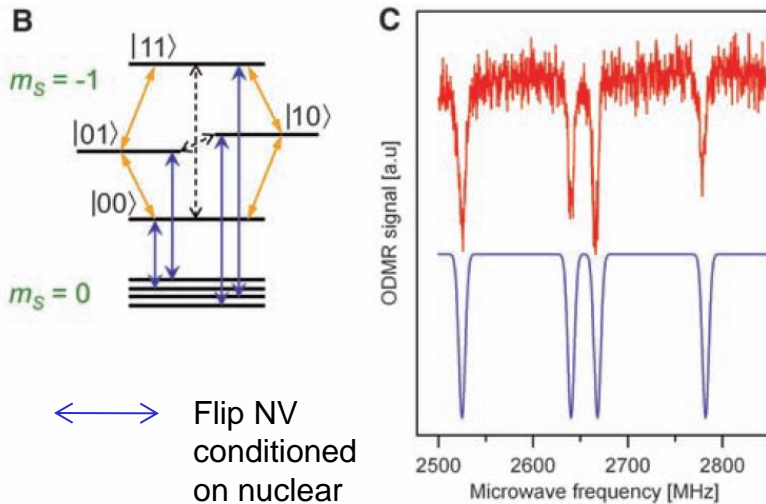

↔ Flip NV
conditioned
on nuclear
state

↔ Flip nuclei
conditioned
on NV and nuclear
state

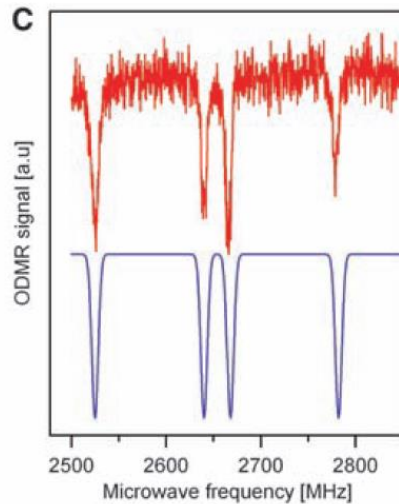

- Creation of entangled states possible $|00\rangle \mp |11\rangle$

P. Neumann et al., Science **320**, 1326 (2008)

- Scaling up to four nuclear spins straightforward,
- Scaling to 10-20 spins presumably possible

Different development: QND readout of nuclear spins

Readout of single quantum systems

Standard readout

<1 photon per run

limited by photon shot noise (at best)

Example: fluorescence detection of single NV

Single shot readout

determine spin state in a single run but
destroy the system or its quantum state

(requires >1 photon per run)

limited by quantum shot noise

Example: Photon detection in Photomultiplier

Quantum non demolition (QND) readout

>1 photon per run

and preservation of the system and its spin state

Projective measurement

Example: Microwave photons in cavity (Haroche)

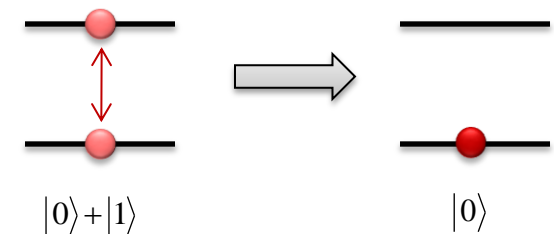

QND readout of a single nuclear spin

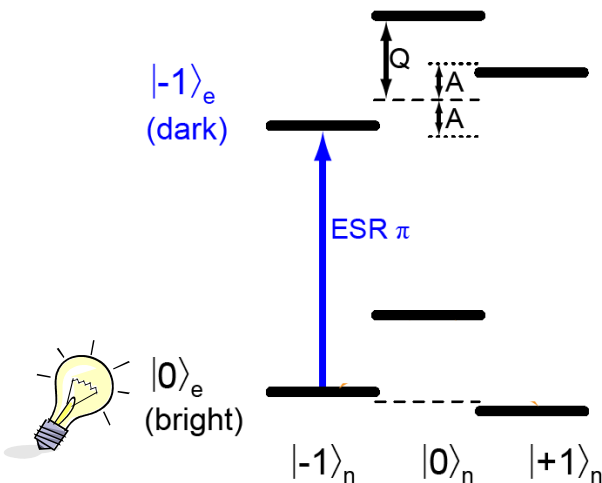
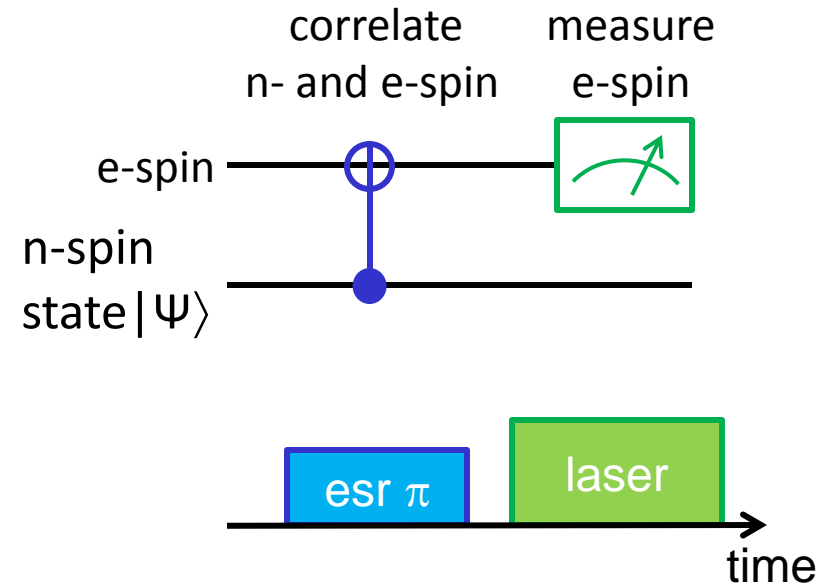
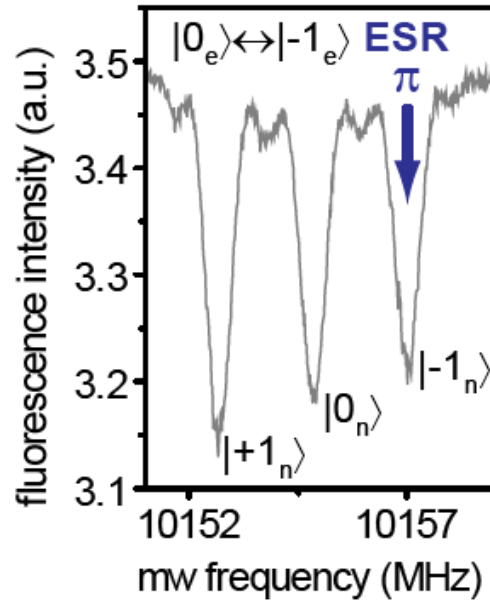
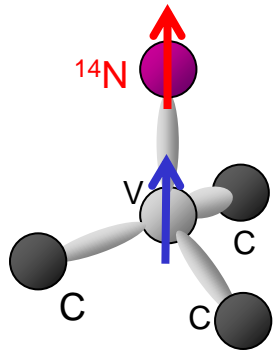

Observing flips of a single nuclear spin

- Repetitive QND measurements reveal quantum jumps of a single nuclear spin (in diamond at room temperature)

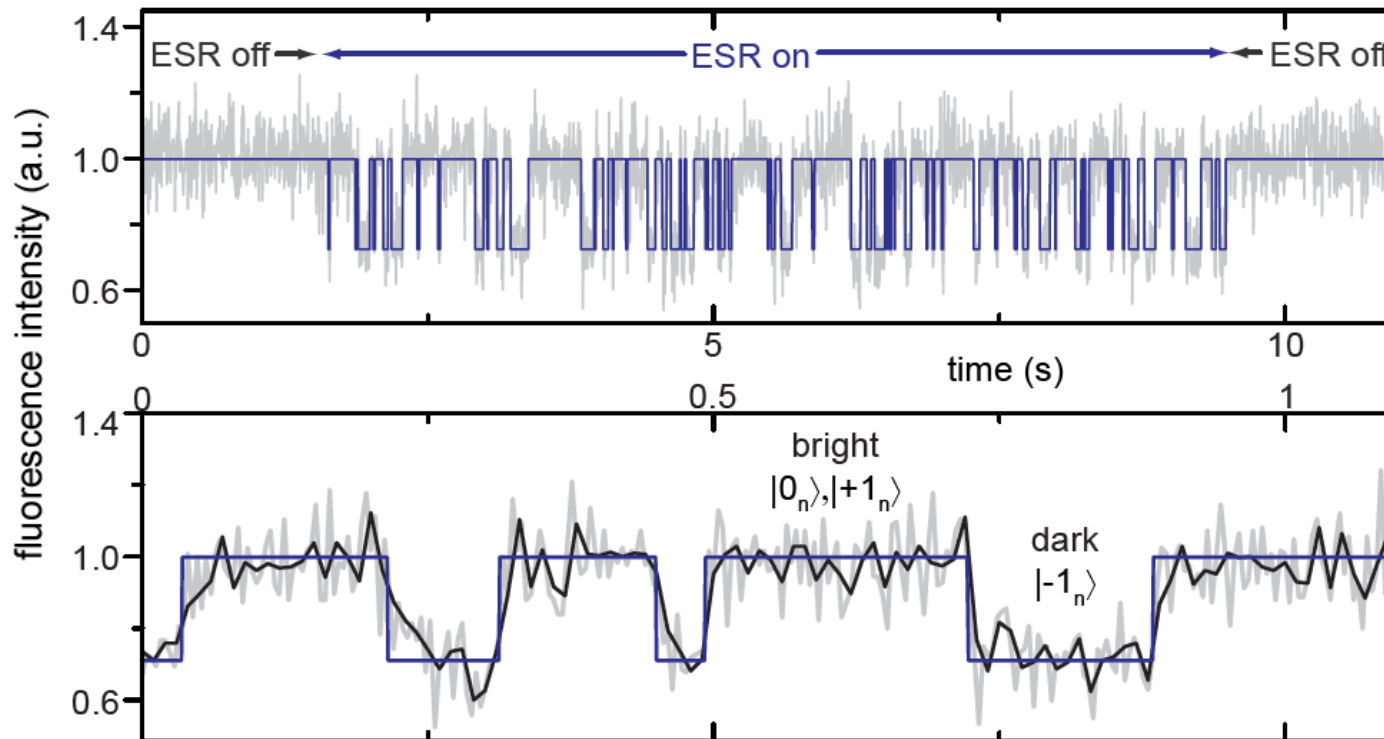

Fidelity of spin state detection

➤ Photon counting histogram of timetrace

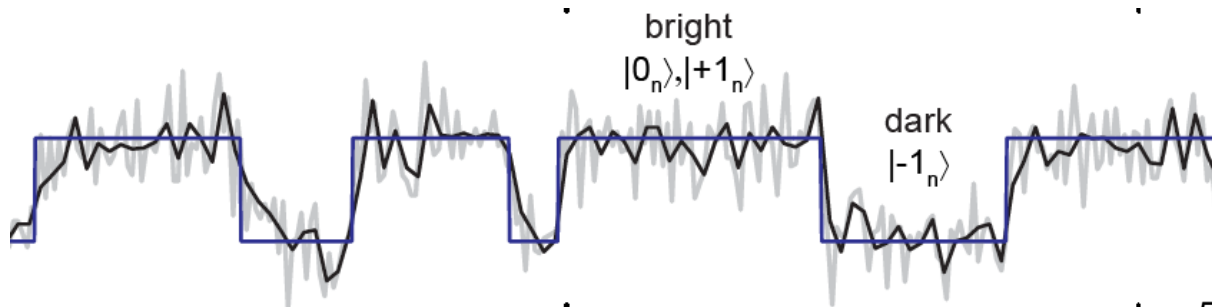

- Two almost perfect Poissonians
- Threshold for state discrimination
 - Fidelity from overlap 99%
 - Fidelity to detect given state 92%

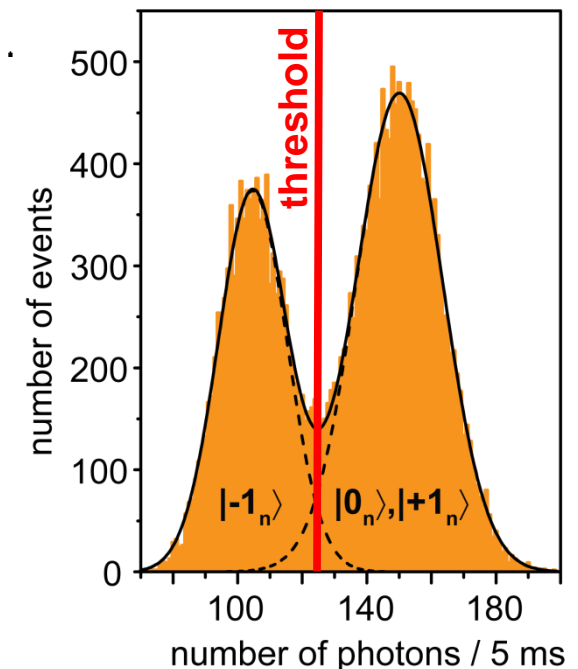

Coupling NV centers

Photons

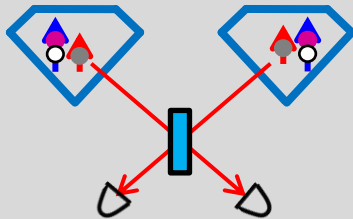

Cirac, Zoller
Lukin `06

- Proper levels and transitions

Manson, Hemmer, Santori

- Transfer limited photons:
Batalov et al. PRL 08
- But: bad coupling efficiency

Magnetic Dipolar coupling

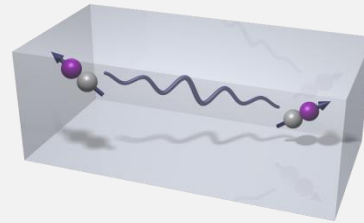

- Magnetic dipoles

$$d_{\text{coherent}} \propto \sqrt[3]{T_2}$$

Use nuclear spin qubits

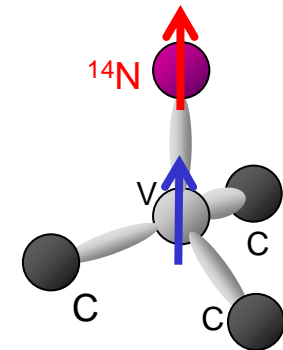

- Couple NV to surrounding nuclei
- Couple nuclei via NV
- Read out single nuclei